



TILES ALBERA / MONTGÓ

SUNBREAKS MONTGRÍ / EMPÚRIES

CORNERS FINAL / ANGLE 90 / ARC 120 / ARC 90

# Albera

La baldosa Albera se caracteriza por sus ondas asimétricas que generan un ligero volumen sinuoso alternando planos y curvas. Su relieve zigzagueante genera en el muro un original plisado cerámico.

The Albera tile is characterized by its asymmetrical waves generating a light sinuous volume with alternating planes and curves. Its zigzagging surface transforms the wall to create an original ceramic pleated effect.

Diseñada por Emiliana Design Studio

Designed by Emiliana Design Studio

## Dimensiones

Debido a las características técnicas del material, las piezas fabricadas en Terracota Arena 14 varían ligeramente en dimensiones y peso.

## Dimensions

Due to the technical properties of the material, the pieces manufactured in Terracotta Arena 14 vary slightly in size and weight.



**Terracota Rojo 15**  
Medidas / Size: 20,5 x 31,2 cm  
Peso / Weight: 2,25 kg



**Terracota Arena 14**  
Medidas / Size: 19,8 x 30,5 cm  
Peso / Weight: 2,35 kg

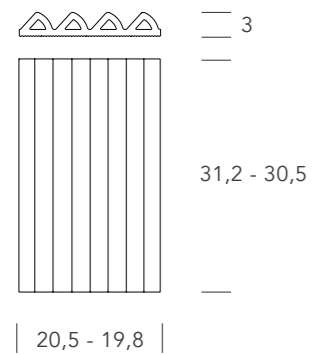

Material Cerámica / Ceramic

Acabados / Finishes



Disponible en acabados cerámicos: Terracota Rojo 15 y Terracota Arena 14.  
It is available in ceramic finishes: Terracotta Rojo 15 and Terracotta Arena 14.

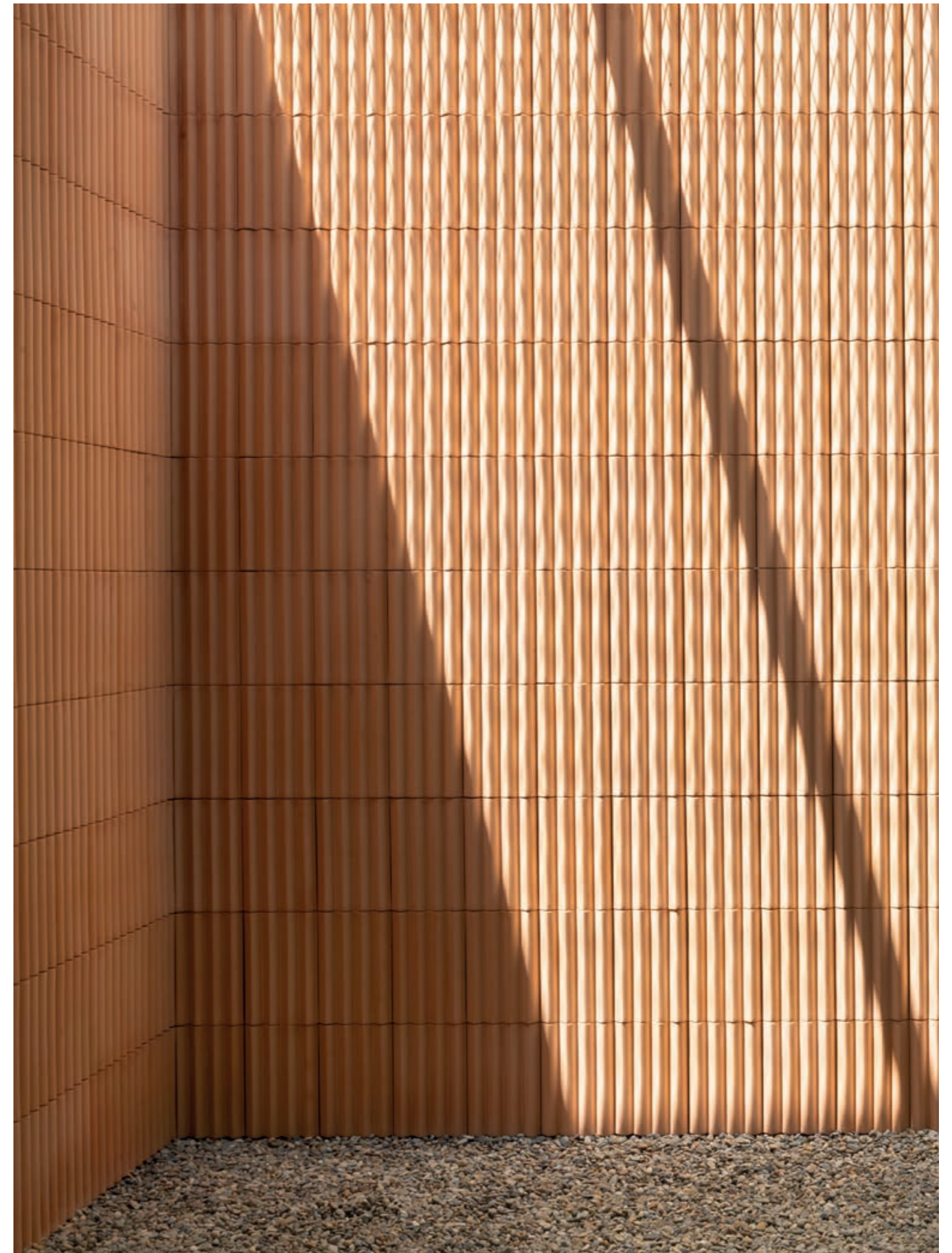

Albera — Terracota Arena 14



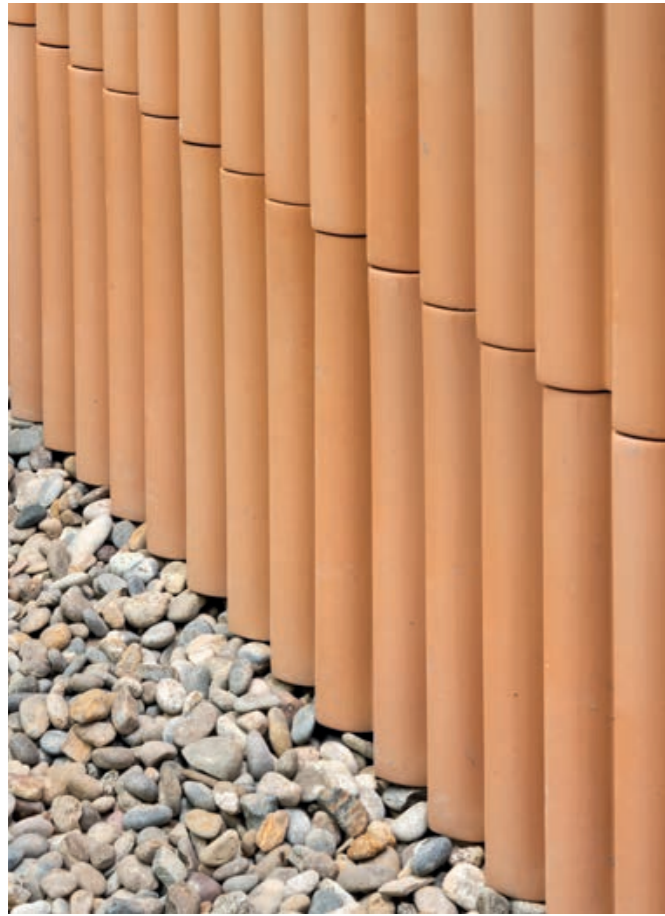

Albera — Terracota Arena 14



Albera — Terracota Rojo15

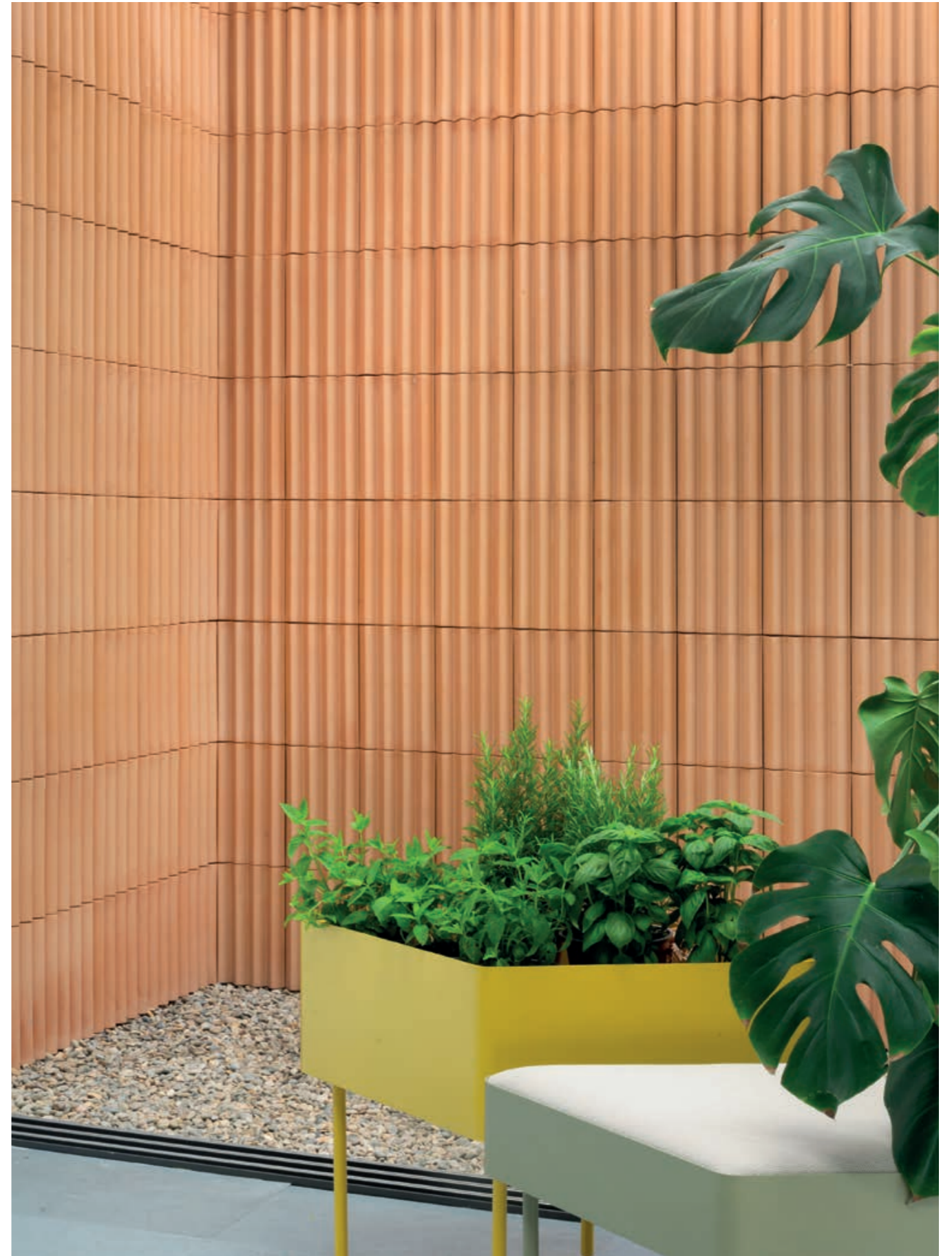

Albera — Terracota Arena 14



# Montgó

La baldosa Montgó se caracteriza por ser una pieza volumétrica que crea un particular revestimiento cerámico ondulante.

Diseñada por Emiliana Design Studio

**Dimensiones**  
Debido a las características técnicas del material, las piezas fabricadas en Terracota Arena 14 varían ligeramente en dimensiones y peso.

●  
**Terracota Rojo 15**  
Medidas / Size: 20,5 x 31,2 cm  
Peso / Weight: 3,3 kg

●  
**Terracota Arena 14**  
Medidas / Size: 19,8 x 30,5 cm  
Peso / Weight: 3,45 kg

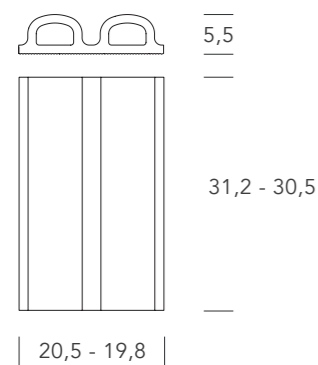

Material Cerámica / Ceramic

Acabados / Finishes



Disponible en acabados cerámicos: Terracota Rojo 15 y Terracota Arena 14.  
It is available in ceramic finishes: Terracotta Rojo 15 and Terracotta Arena 14.

The Montgó tile is characterized for being a volumetric piece that creates a particular undulating ceramic cladding.

Designed by Emiliana Design Studio

**Dimensions**  
Due to the technical properties of the material, the pieces manufactured in Terracotta Arena 14 vary slightly in size and weight.



Montgó — Terracota Arena 14



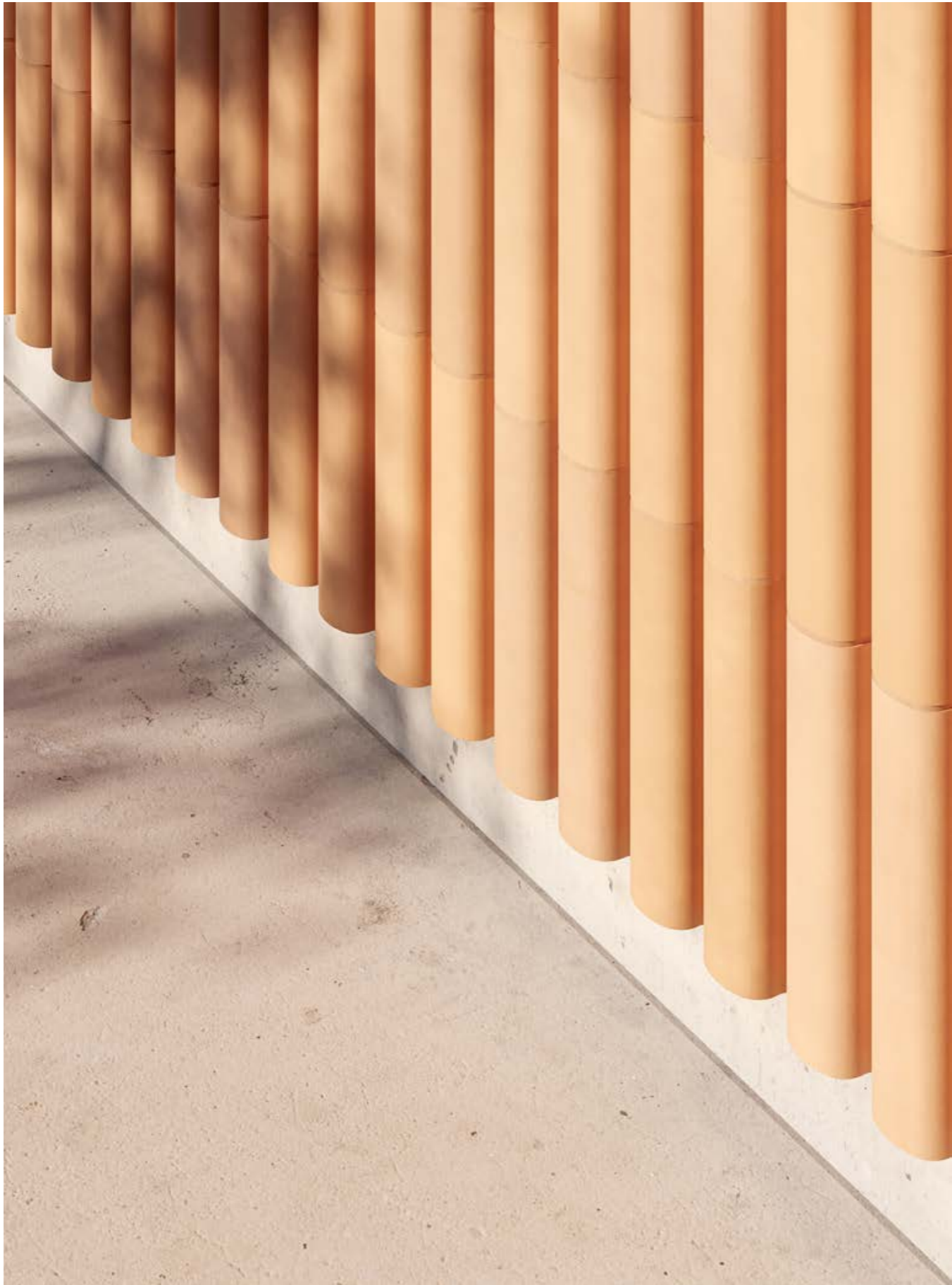

Montgó — Terracota Arena 14



Montgó — Terracota Arena 14

# Montgrí

Montgrí se inspira en el popular recurso de construcción de barandillas en las antiguas masías catalanas. Los triángulos de la pieza consiguen, mediante la repetición, una celosía con un dinámico juego de diagonales entrecruzadas.

Montgrí is inspired by the popular use of railings in old Catalan farmhouses. The triangles of the piece achieve, through repetition, a lattice with a dynamic play of intertwined diagonals.

## Dimensiones / Dimensions

Medidas / Size: 19 x 19 x 7 cm  
Peso / Weight: 2,20 kg

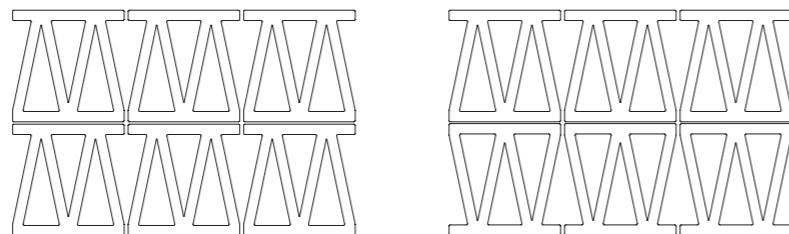
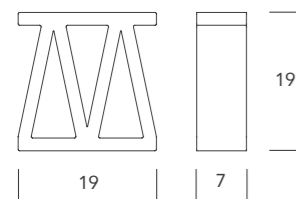

## Material Cerámica / Ceramic

### Acabados / Finishes



Se encuentra en todos los acabados cerámicos: terracota, vidriados y esmaltados.  
It is available in all ceramic finishes: terracotta, glazed and enameled.



Montgrí — Terracota Arena 14





Montgrí — Terracota Arena 14



Casa Pin-8 / Arquitectura: PMMT Arquitectura / Fotografía: Del Río Bani

Montgrí — Terracota Arena 14



# Empúries

Las celosías Empúries son simples y lineales. Sus diferentes modelos permiten tres niveles de transparencia u opacidad. Todas sus piezas son combinables entre ellas lo que facilita infinitas configuraciones que generan una trama de líneas verticales y un sutil ritmo visual.

Diseñada por Emiliana Design Studio

## Dimensiones

Debido a las características técnicas del material, las piezas fabricadas en Terracota Arena 14 varían ligeramente en dimensiones y peso.



### Terracota Rojo 15

Medidas / Size: 21 x 27x 7 cm

Peso / Weight: **A** 2,50 kg; **B** 3 kg; **C** 3,50 kg

**A**

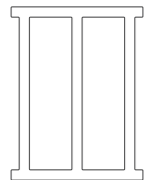

| 21 - 20,5 |

**B**



| 21 - 20,5 |

**C**

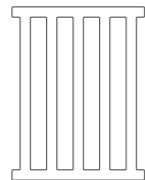

| 21 - 20,5 |



27 - 26,5

| 7 |

Material Cerámica / Ceramic

Acabados / Finishes



Disponible en acabados cerámicos: Terracota Rojo 15 y Terracota Arena 14.

It is available in ceramic finishes: Terracotta Rojo 15 and Terracotta Arena 14.



**Novedad!** Celosía compatible con los Corners  
**New!** Lattice compatible with the Corners

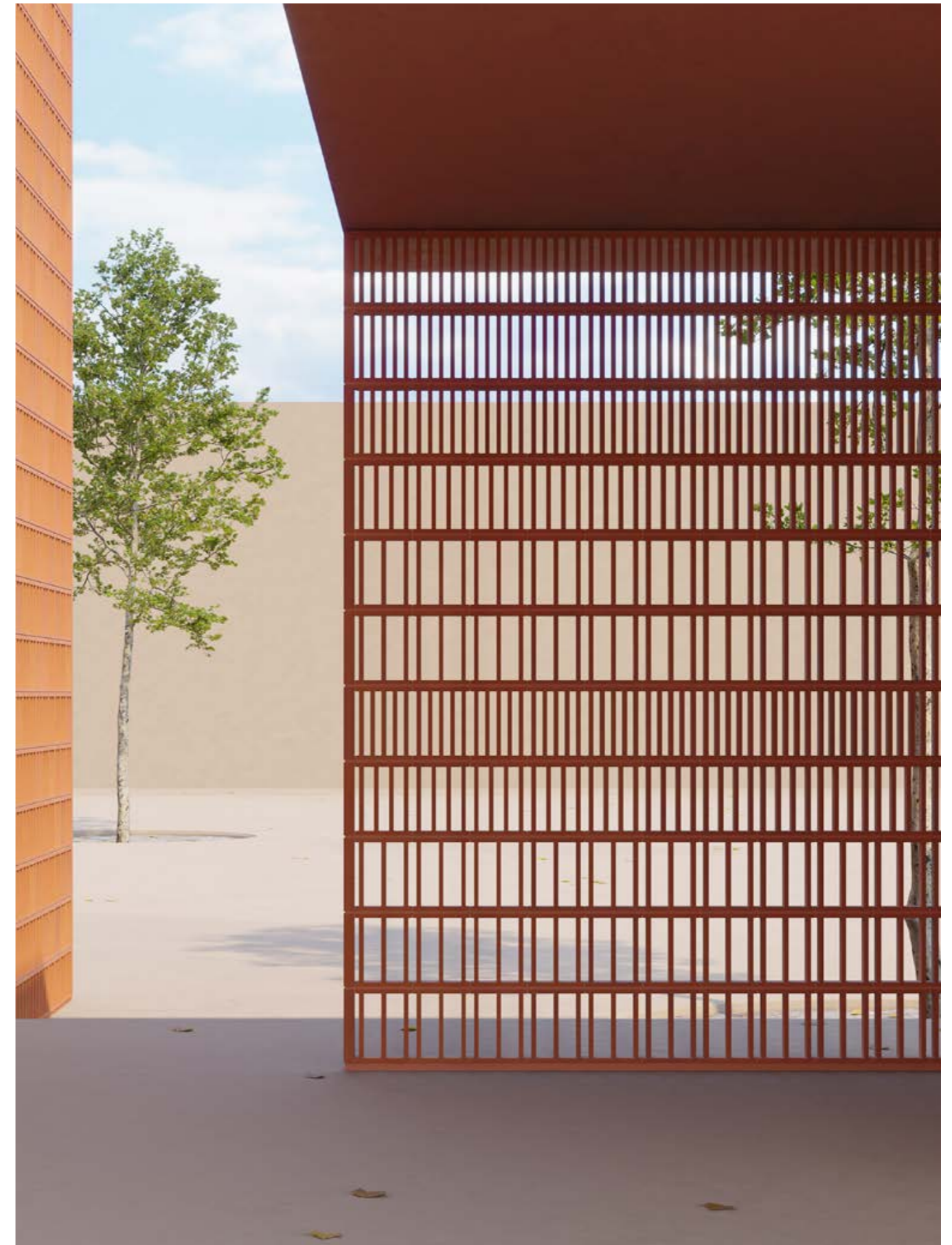

Empúries — Terracota Rojo 15



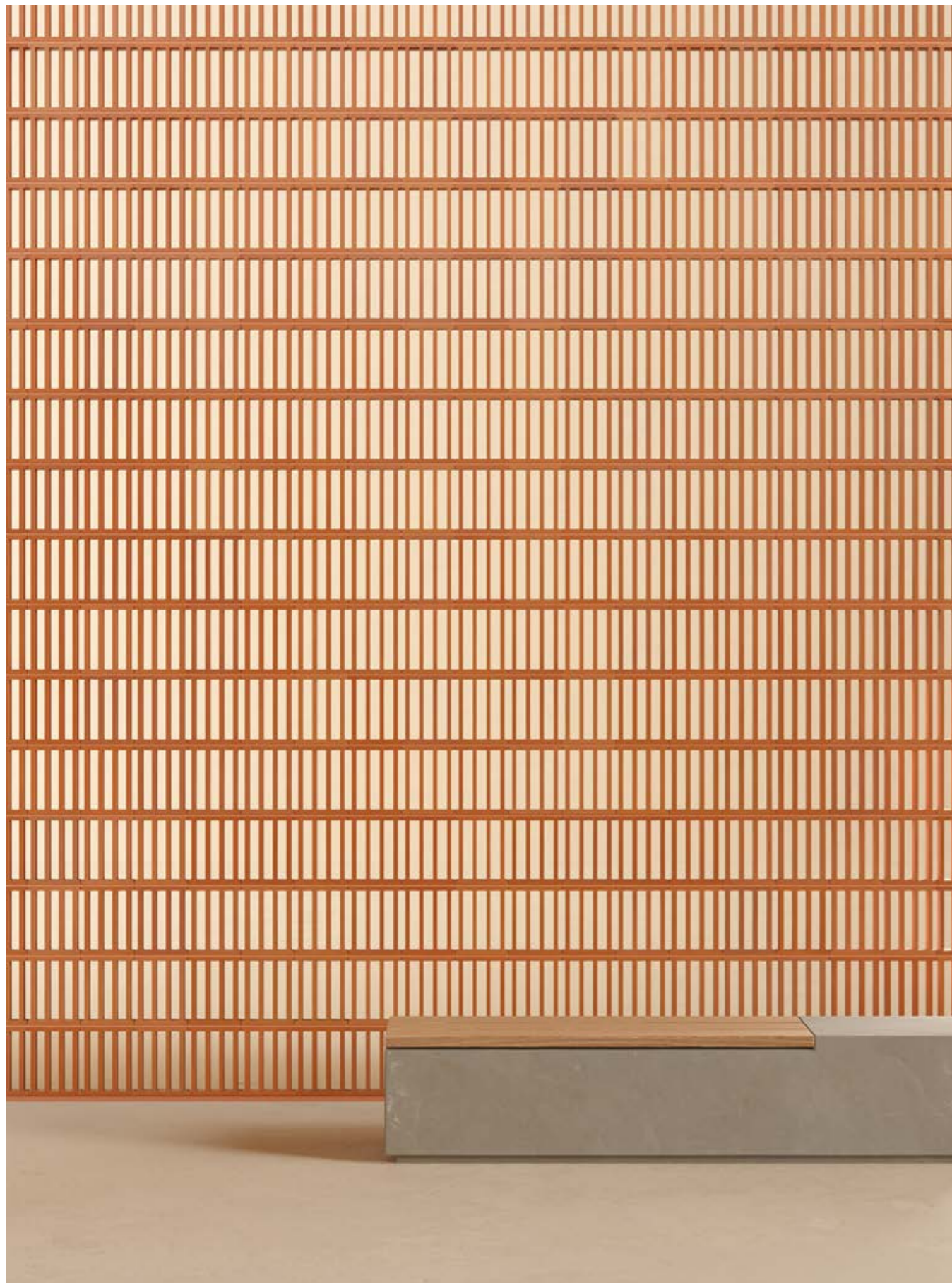

Empúries — Terracota Rojo 15



Empúries — Terracota Rojo 15



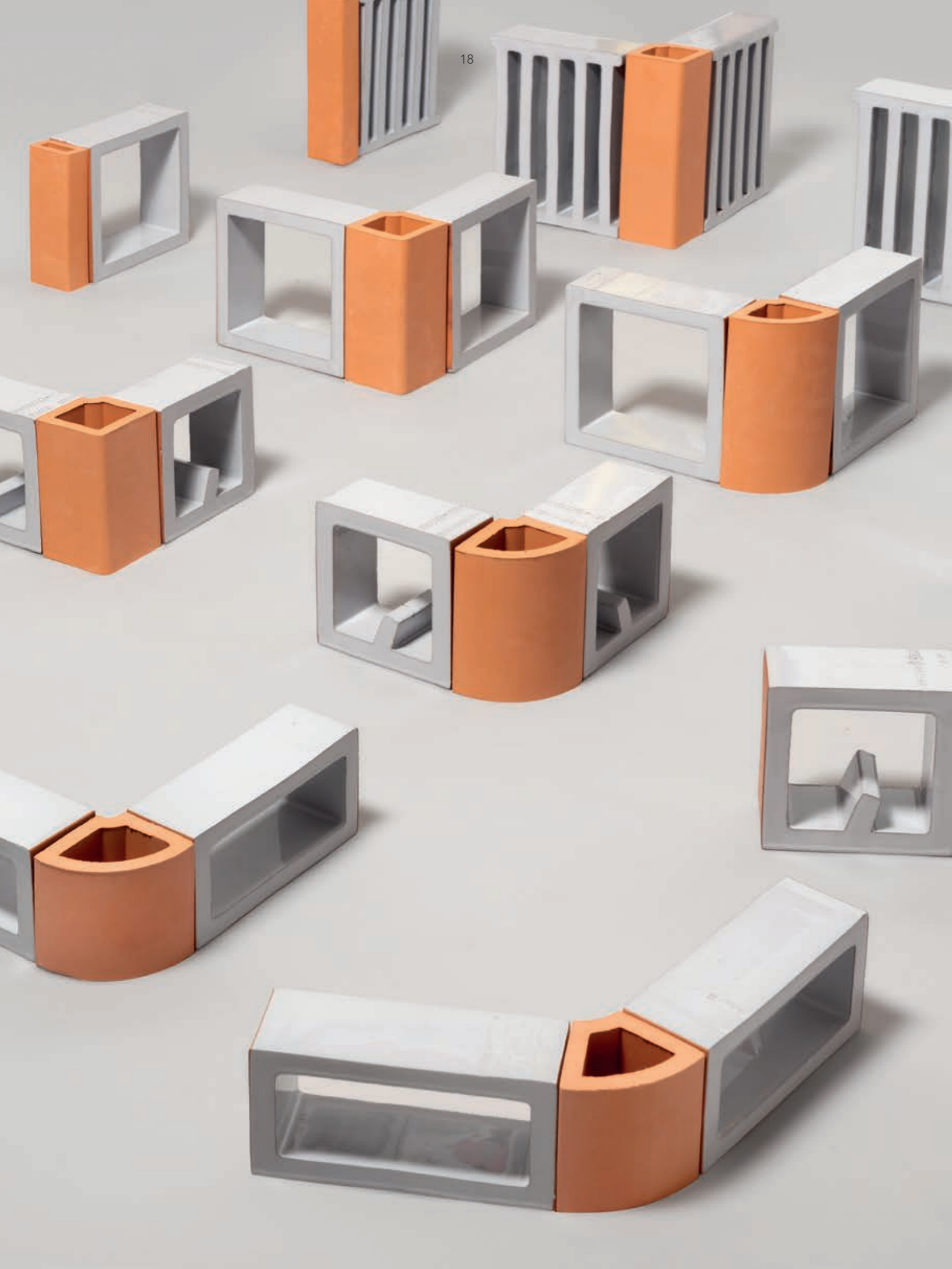

# Corners

Designed by Emiliana Design Studio

La colección de piezas Corner son una familia de elementos finales o en esquina que conectan celosías para configurar biombos, muros exentos y barandas. La novedad de esta colección, Final, Angle 90, Arc 90 y Arc 120, reside en que estas piezas conectoras son compatibles con las celosías Empúries / Norfeu / Rectangular / Cuadrada.

20

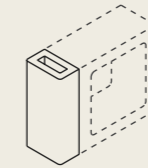

Corner Final

22

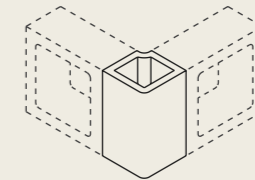

Corner Angle 90

24

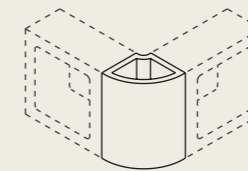

Corner Arc 90

26

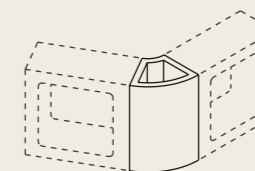

Corner Arc 120

The Corner collection is a family of end or corner elements that connect lattices to form screens, free-standing walls and railings. The novelty of this collection, Final, Angle 90, Arc 90 and Arc 120, lies in the fact that they are connecting pieces which can be combined with the lattices Empúries / Norfeu / Rectangular / Cuadrada.





Corner Final



Corner Final — Azul 64  
Sunbreak Norfeu

La pieza cerámica Corner Final, permite rematar el extremo de las celosías con un final limpio. Al ser hueca, esta pieza facilita además el anclaje al suelo y techo mediante una varilla corrugada.

The Corner Final ceramic piece allows the end of the trusses to be finished off with a clean finish. The fact that this piece is hollow also facilitates anchorage to the floor and ceiling by means of a ribbed rod.

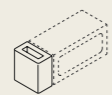
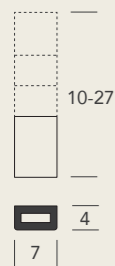

7x10x4

Compatible:  
Rectangular

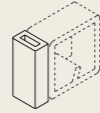

7x15x4

Compatible:  
Norfeu  
Cuadrada

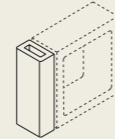

7x20x4

Compatible:  
Cuadrada  
Rectangular

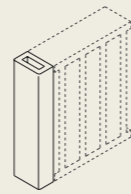

7x27x4

Compatible:  
Empúries

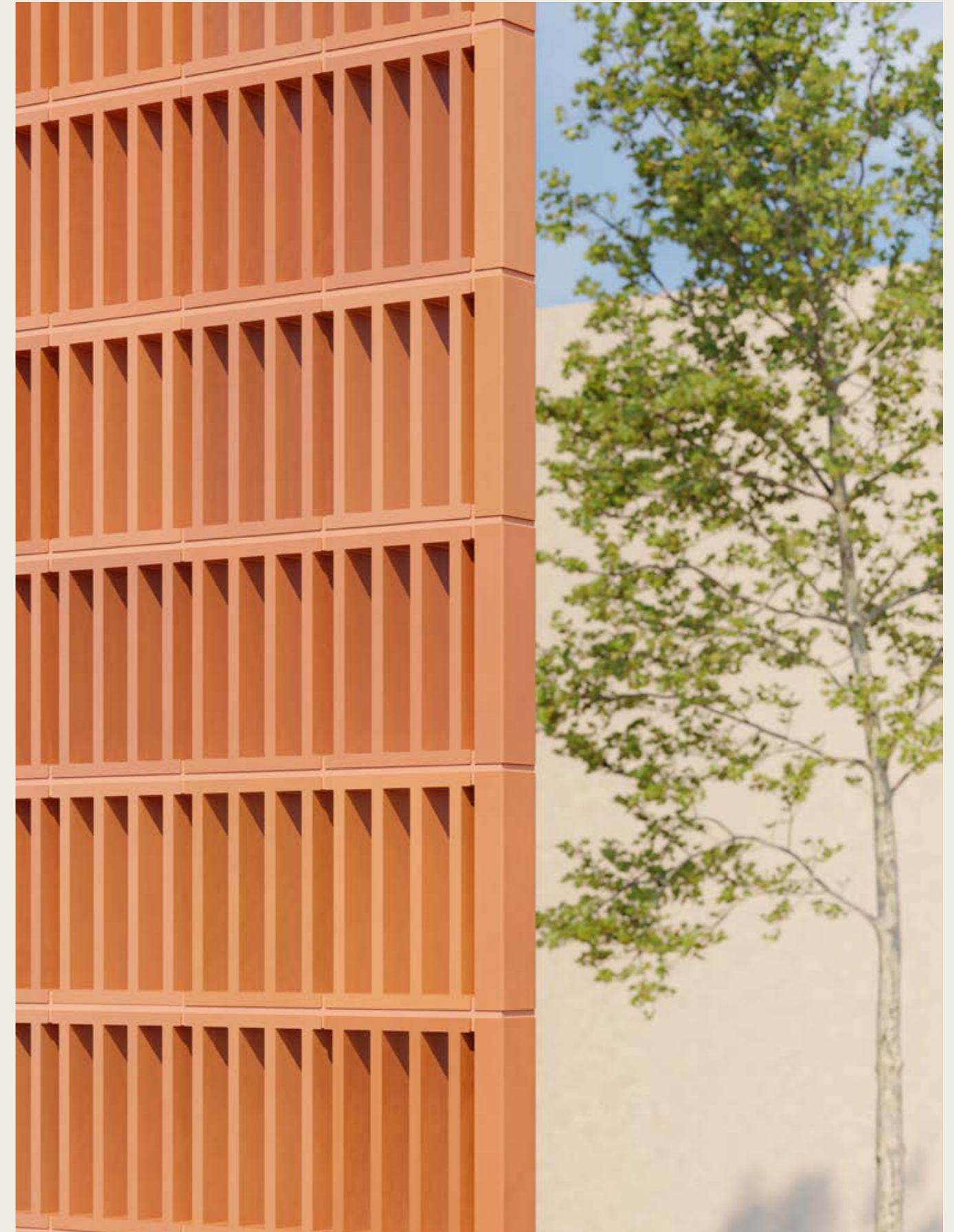

Corner Final — Terracota Rojo 15  
Sunbreak Empúries



Disponibile en todos los acabados cerámicos: terracota, vidriados y esmaltados. Ver la gama completa en el catálogo general p. 94-95.  
It is available in all ceramic finishes: terracotta, glazed and enameled. See full gamma in the general catalogue on p.94-95.





Corner Angle 90

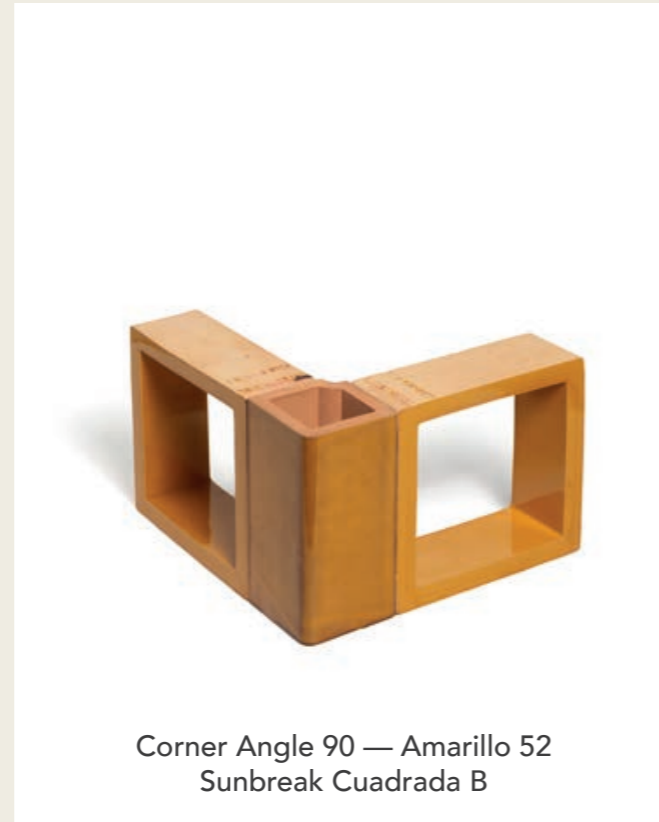

Corner Angle 90 — Amarillo 52  
Sunbreak Cuadrada B

La pieza cerámica Corner Angle 90°, con su diseño de líneas rectas, permite conectar celosías entre sí para configurar esquinas a 90° en biombos, muros exentos y barandas. Al ser hueca, esta pieza facilita además el anclaje al suelo y techo mediante una varilla corrugada.

The Corner Angle 90° ceramic piece, with a straight-lined design, can be used to connect lattices to each other to form 90° corners in screens, free-standing walls and railings. The fact that this piece is hollow also facilitates anchorage to the floor and ceiling by means of a ribbed rod.

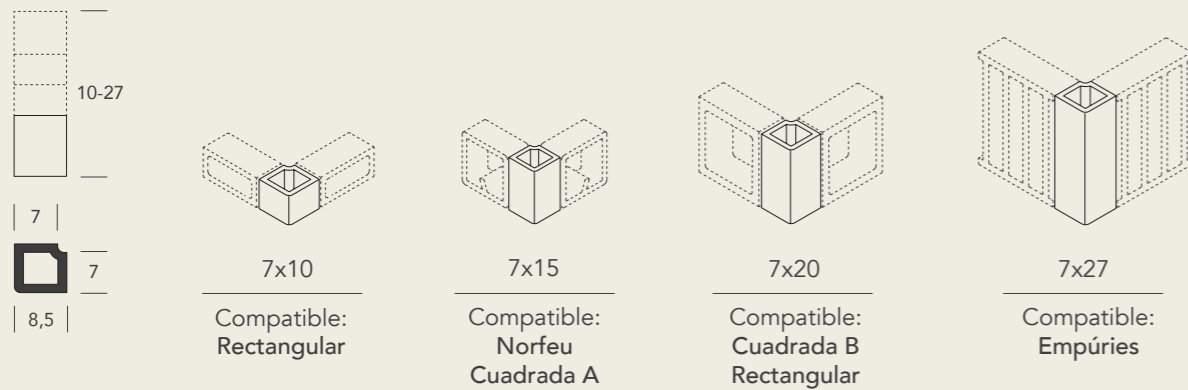

Corner Angle 90 — Terracota Arena 14  
Sunbreak Cuadrada A





Corner Arc 90



Corner Arc 90 — Gris 12  
Sunbreak Rectangular

La pieza cerámica Corner Arc 90°, con su diseño curvo, permite conectar celosías entre sí para configurar esquinas a 90° en biombos, muros exentos y barandas. Al ser hueca, esta pieza facilita además el anclaje al suelo y techo mediante una varilla corrugada.

The Corner Arc 90° ceramic piece, with a curved design, can be used to connect lattices together to form 90° corners in screens, free-standing walls and railings. The fact that this piece is hollow also facilitates anchorage to the floor and ceiling by means of a ribbed rod.

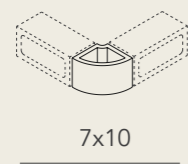
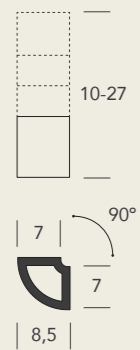

7x10  
Compatible:  
Rectangular

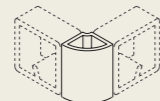

7x15  
Compatible:  
Norfeu  
Cuadrada

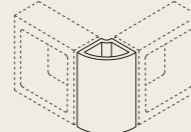

7x20  
Compatible:  
Cuadrada  
Rectangular

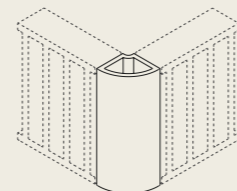

7x27  
Compatible:  
Empúries



Corner Angle 90 — Terracota Rojo 15  
Sunbreak Norfeu



Disponible en todos los acabados cerámicos: terracota, vidriados y esmaltados. Ver la gama completa en el catálogo general p. 94-95. It is available in all ceramic finishes: terracotta, glazed and enameled. See full gamma in the general catalogue on p.94-95.





Corner Arc 120

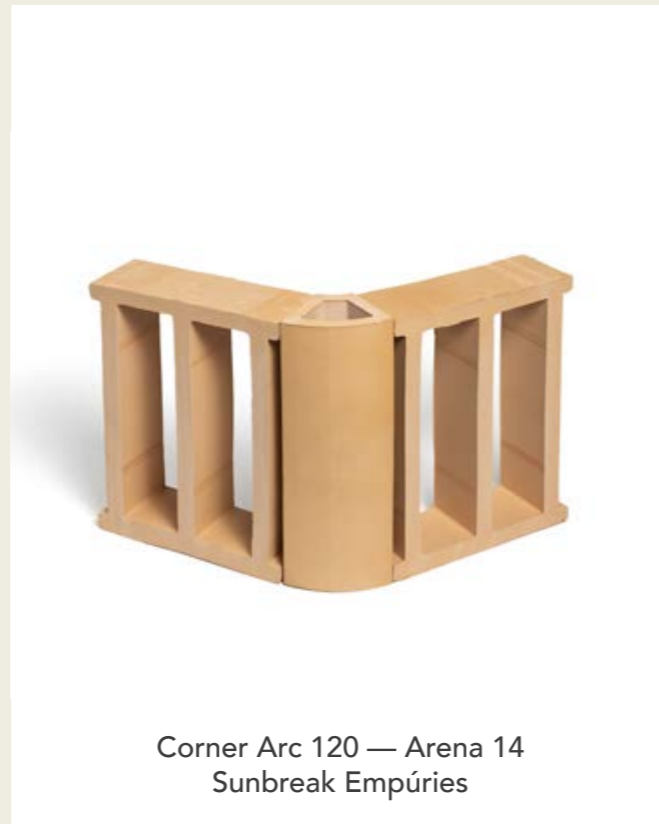

Corner Arc 120 — Arena 14  
Sunbreak Empúries

La pieza cerámica Corner Arc 120°, con su diseño curvo, permite conectar celosías entre sí para configurar uniones a 120° en biombos, muros exentos y barandas. Al ser hueca, esta pieza facilita además el anclaje al suelo y techo mediante una varilla corrugada.

The Corner Arc 120° ceramic piece, with a curved design, can be used to connect lattices to each other to form 120° joints in screens, free-standing walls and railings. The fact that this piece is hollow also facilitates anchorage to the floor and ceiling by means of a ribbed rod.

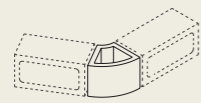
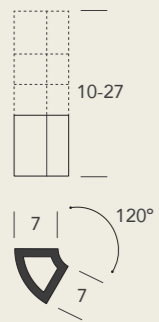

7x10

Compatible:  
Rectangular



7x15

Compatible:  
Norfeu  
Cuadrada

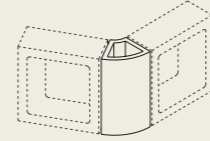

7x20

Compatible:  
Cuadrada  
Rectangular

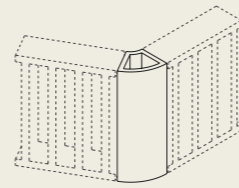

7x27

Compatible:  
Empúries



Corner Angle 120 — Amarillo 52  
Corner Final, Sunbreak Rectangular



Disponibile in todos los acabados cerámicos: terracota, vidriados y esmaltados. Ver la gama completa en el catálogo general p. 94-95.  
It is available in all ceramic finishes: terracotta, glazed and enameled. See full gamma in the general catalogue on p.94-95.



