

FERRÉS
CERÀMICA · GRES



Corner Arc 90

Corner Arc 90

La pieza cerámica Corner Arc 90, con su diseño curvo, permite conectar celosías entre sí para configurar esquinas a 90° en biombos, muros exentos y barandas.

The Corner Arc 90 ceramic piece, with a curved design, can be used to connect lattices together to form 90° corners in screens, free-standing walls and railings.

Modelos / Models

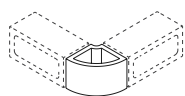
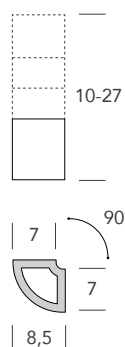

7x10

Compatible:
Rectangular A

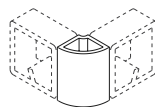

7x15

Compatible:
Norfeu
Cuadrada

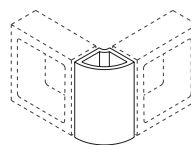

7x20

Compatible:
Cuadrada
Rectangular A

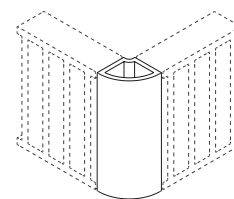

7x27

Compatible:
Empúries

Material Cerámica / Ceramic

Acabados / Finishes

Terracota



Rojo 15

Arena 14

Esmaltado / Glaze



Blanco 23

Gris 12

Vidriado / Glaze



Paja 10

Amarillo 50

Amarillo 52

Beig 85

Tabaco 16

Marrón 95

Negro 13



Rojo 24

Rojo 92

Verde 28

Verde 31

Azul 62

Azul 64

Azul 43

La medida puede sufrir una variación de 2-4mm según tipo de arcilla o acabado. Por este motivo se recomienda no realizar ningún montaje previo para insertar la celosías hasta recibirlos en obra.

The measure can undergo a variation of 2-4mm depending on the type of clay or finish. For this reason, it is recommended not to carry out any previous assembly to insert the lattices until they are received on site.

Puede que haya ligeras variaciones entre piezas del mismo color o de diferentes colores.

There may be slight variations among pieces of the same color or different colors.

Ceràmica Ferrés

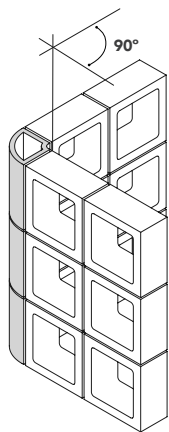

Formando esquina /
Forming corner

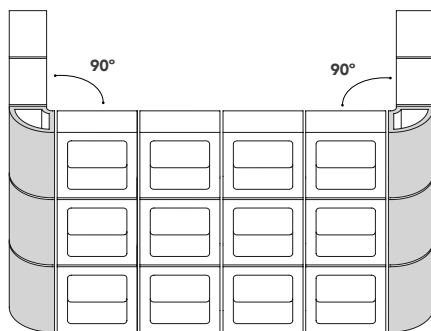

Construyendo un cerramiento /
Building an enclosure

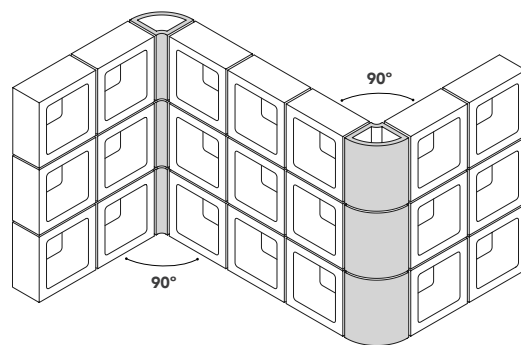

En Zigzag /
Zigzagging

Compatible: Celosía/Lattice Rectangular A, Norfeu, Cuadrada, Empúries

El interior vacío de la pieza Corner facilita el anclaje al suelo y techo mediante una varilla corrugada.

The Corner piece is hollow to facilitate anchoring to the floor and ceiling using a ribbed rod.

